



Indexable Drills Series

P2D P3D P4D P5D

Volume 5.1



KEY FEATURES: PHOENIX P2D P3D P4D P5D

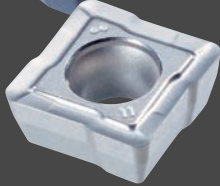
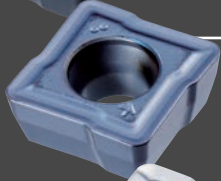
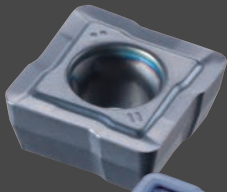

- New chipbreakers available for a wide variety of materials

1 Economical 4-corner design

2 Unique flute design enables stable drilling

3 Using same insert to both center and peripheral cutting edge simplify tool management

4 High precision finishing of the flute surface improves chip evacuation

5 Internal coolant system



PD-SERIES: NEW SIZES AVAILABLE NOW

3 types of chipbreakers for a variety of work material in large size range

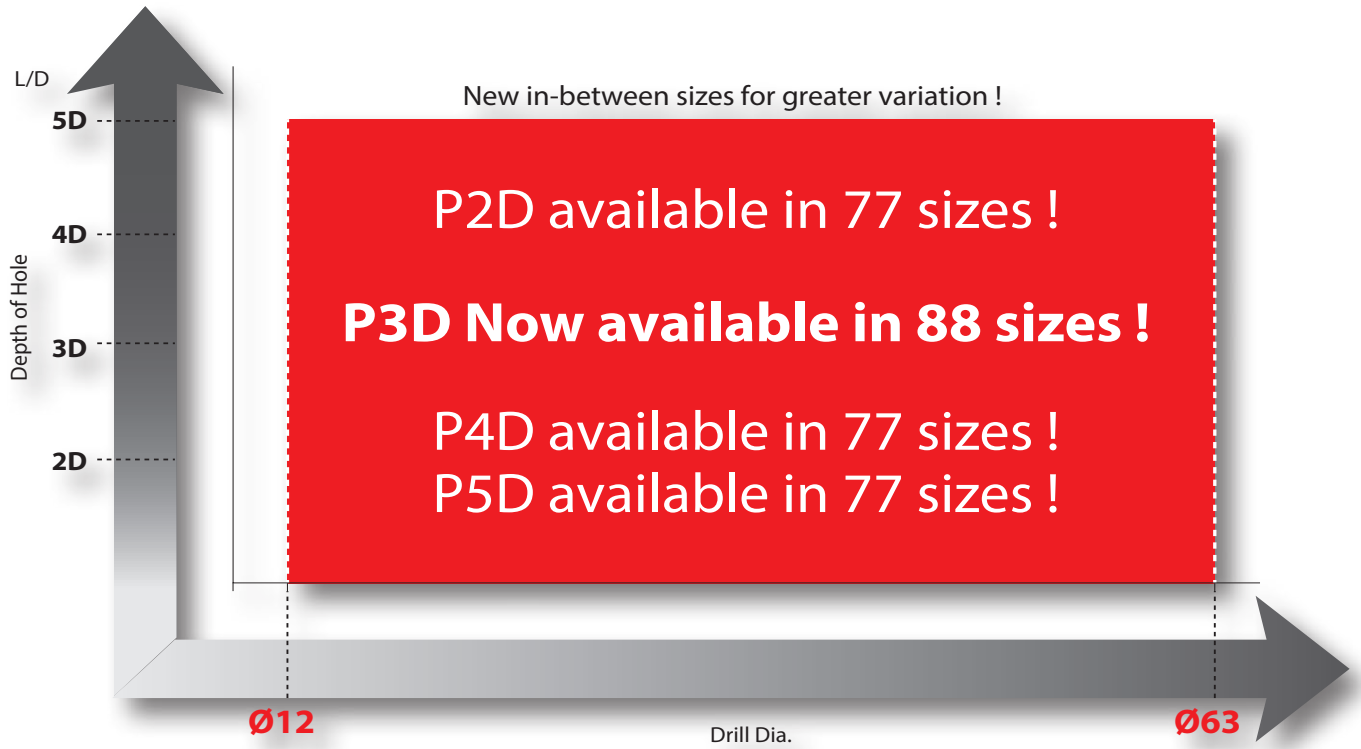

PHOENIX XCMT INSERTS

Drilling | Indexable | Inserts

Three types of chipbreakers are available for a wide variety of work material

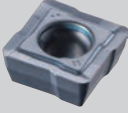

For Steel and Stainless Steel (DM)

- Well balanced insert with sharpness and rigidity

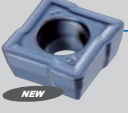

For Cast Iron (DR)

- Strong cutting edge acquired by rake angle and land



For Aluminum Alloy and Nonferrous Metal (DN)

- Excellent chip evacuation is acquired by sharp cutting edges and polishing treatment

• Turning internal diameter

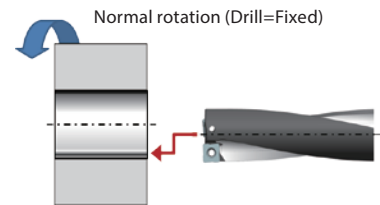

• Turning outer diameter

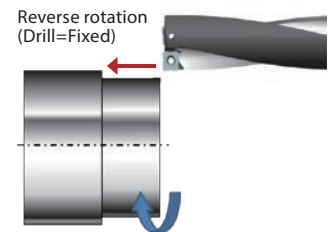

Chipbreaker	Classification	Grades	Coating Method	(HRA) Hardness	Surface Treatment	
					Main Component	Coating Thickness
DM	P	XP9020	PVD	91.9	TiAlN	3µm
DR	K	XP1010	PVD	91.4	TiAlN	6µm
DN	N	CK110	—	92.2	—	—

MATERIAL OVERVIEW

Work Material		DIN
P	C: ≤0,2%	Low carbon steel 1.0116 (S235J2G3) 1.0401 (C15)
	C: 0,25-0,45%	Medium carbon steel 1.0501 (C35)
	C: ≥0,45%	High carbon steel 1.0535 (C55) 1.0553 (S355J0)
	SCM	Alloy steel 1.7225 (42CrMo4)
M	INOX	Stainless steel 1.4301 (X5CrNi18-10)
K	GG	Cast iron 0.6025 (EN-GJL-250/GG25)
	GGG	Ductile cast iron 0.7040 (EN-GJS-400-15/GGG-40)
N	Al	Aluminium 3.0205 (Al99)
	AC, ADC	Cast aluminium alloys 3.2581 (G-AlSi12)
S	Ti	Titanium 3.7164 (Ti6Al4V)
	Ni	Nickel alloys 2.4816 (NiCr15Fe/Inconel® 600)
H	25-35HRC	Hardened steel
	35-45HRC	
	45-52HRC	
	52-62HRC	

Achieves stable drilling, even when making rigorous 5xD deep holes

Work Material	S50C
Drill Diameter	Ø 25
Depth of hole	125 mm
Cutting Condition	$V_C=150\text{m/min}$ $f=0,12\text{mm/rev}$
Coolant	Water soluble
Machine	Horizontal Machining Center (BT50)

Conventional Indexable drill

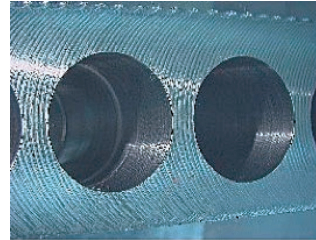

Cross-sectional

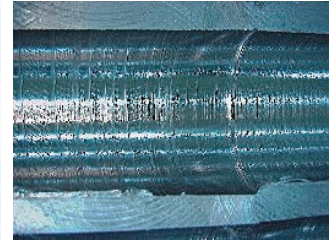

- 5xD deep hole drilling was an extremely difficult process for conventional indexable drills.
 - Since conventional indexable drills are constructed of two flutes and a cutting edge, its load balance is relatively poor especially when drilling deep holes.

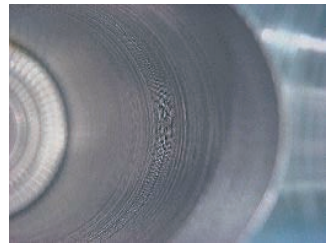
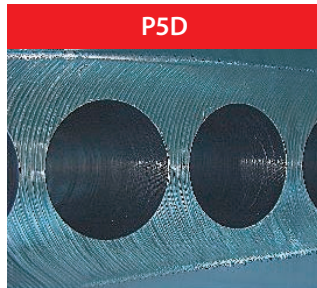

Achieves stable drilling with minimal irregularity. The P5D is designed specifically for stable drilling of 5xD deep holes

Stable cutting load

Work Material	S50C
Drill Diameter	Ø 21
Depth of hole	50 mm
Cutting Condition	$V_C=120\text{m/min}$ $f=0,12\text{mm/rev}$
Coolant	Water soluble
Machine	Horizontal Machining Center (BT50)

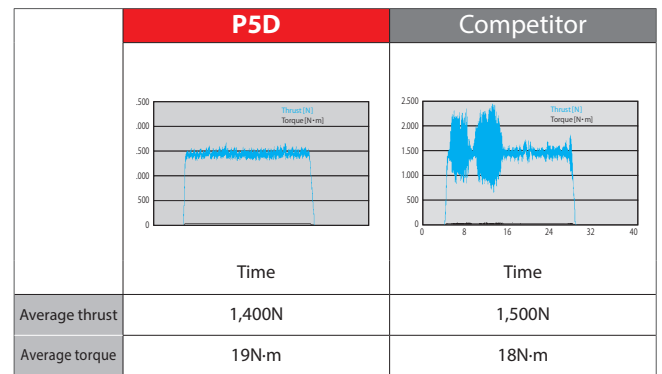

PROCESSING DATA

Drilling | Indexable | Processing data

High efficiency even when drilling deep holes

Tool	P5D2500FS32M08 (Ø25)
Insert Grade	XCMT083508ER-DM
Work Material	S50C
Depth of Hole	120 mm
Coolant	Water soluble (Internal)
Machine	BT50 Horizontal Machining Center

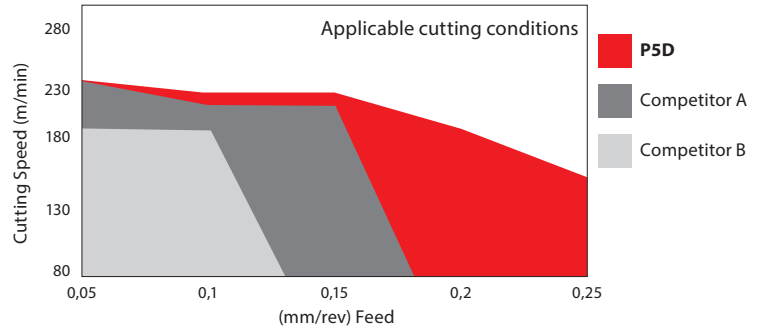

Tool	P5D2500FS32M08 (Ø25)
Insert Grade	XCMT083508ER-DM
Work Material	SCM440 (30HRC)
Depth of Hole	120 mm
Coolant	Water soluble (Internal)
Machine	BT50 Horizontal Machining Center

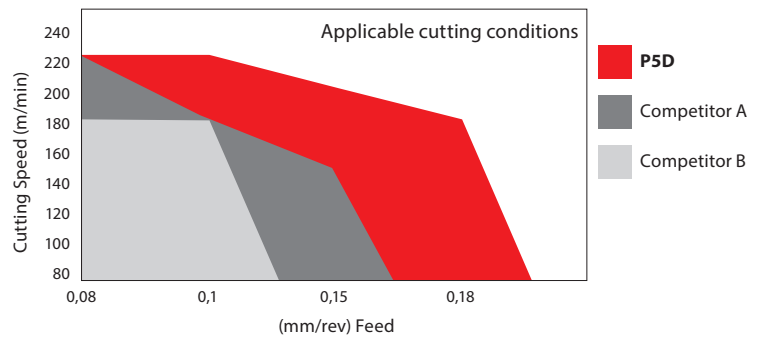

Tool	P5D2500FS32M08 (Ø25)
Insert Grade	XCMT083508ER-DM
Work Material	SUS304
Depth of Hole	120 mm
Coolant	Water soluble (Internal)
Machine	BT50 Horizontal Machining Center

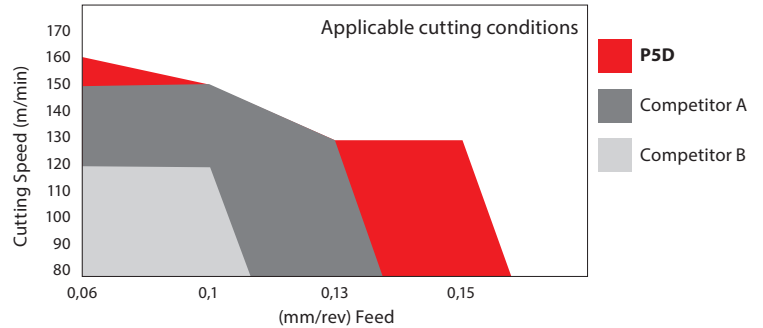

Drilling | Indexable

Processing data

PROCESSING DATA

Drilling | Indexable | Processing data

High efficiency drilling in SUS304 (P3D)

Tool	P3D2500FS32M08 (Ø25)
Insert Grade	XCMT083508ER-DM (XP9020)
Work Material	SUS304
Cutting Speed	160m/min (2.040min ⁻¹)
Feed	400mm/min (0,2mm/rev)
Depth of Hole	75mm (Blind)
Coolant	Water Soluble
Machine	Horizontal Machining Center

The P3D was able to achieve long tool life by drilling SUS 304.

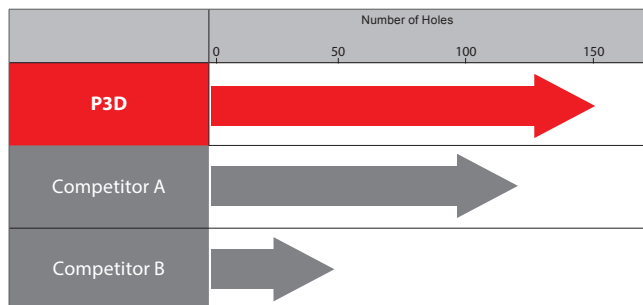

Wear comparison after drilling 48 holes

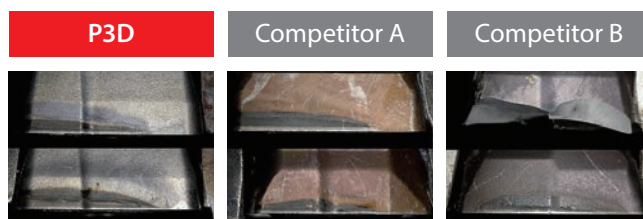

High efficiency drilling in SUS304 (P4D)

Tool	P4D2500FS32M08 (Ø25)
Insert Grade	XCMT083508ER-DM (XP9020)
Work Material	SUS304
Cutting Speed	160m/min (2.040min ⁻¹)
Feed	245mm/min (0,12mm/rev)
Depth of Hole	100mm(Blind)
Coolant	Water Soluble
Machine	Horizontal Machining Center

Long tool life was able to achieve by stable drilling.

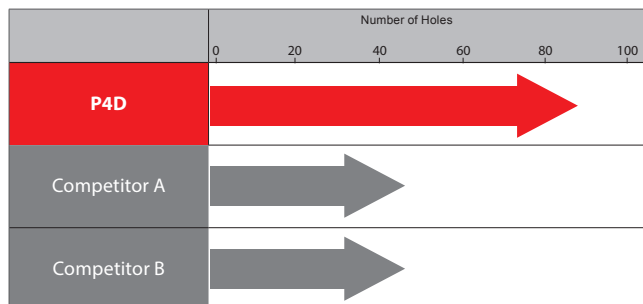

Wear comparison after drilling 45 holes

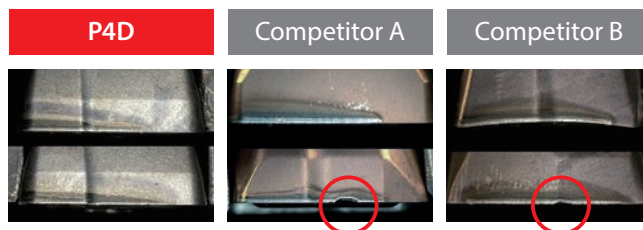

PROCESSING DATA

Drilling | Indexable | Processing data

High efficiency drilling in mold parts (P3D)

Tool	P3D2500FS32M08 (Ø25)	Competitor's Indexable Drill
Insert Grade	XCMT083508ER-DM (XP9020)	Coated Carbide Insert
Work Material	S50C	
Cutting Speed	200m/min (2.550min ⁻¹)	167m/min (2.100min ⁻¹)
Feed	300mm/min (0,12mm/rev)	170mm/min (0,08mm/rev)
Depth of Hole	50mm (Through)	
Coolant	Water Soluble (Internal)	
Machine	Vertical Machining Center	

The competitor product exhibited difficulties in the separation of cutting chips, whereas the P3D was able to break chips into small pieces for trouble-free evacuation, reducing processing time significantly.

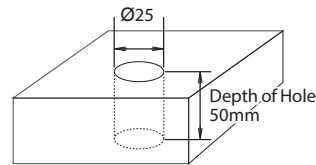
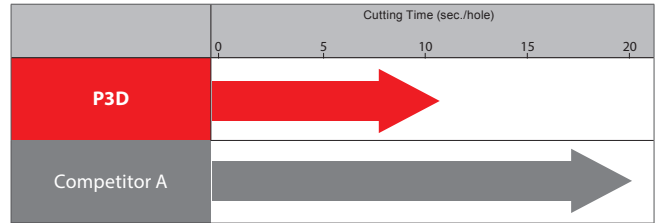

Cutting Chips of P3D

Drilling | Indexable

High efficiency drilling of structural parts (P4D)

Tool	P4D3300FS40M09 (Ø33)	Competitor's Indexable Drill
Insert Grade	XCMT094008ER-DM (XP9020)	Coated Carbide Insert
Work Material	SS400	
Cutting Speed	220m/min (2.100min ⁻¹)	165m/min (1.600min ⁻¹)
Feed	150mm/min (0,07mm/rev)	110mm/min (0,07mm/rev)
Depth of Hole	100mm (Blind)	
Coolant	Water Soluble (Internal)	
Machine	Horizontal Machining Center	

To prevent chip clogging, 2mm step-drilling was commonly required for applications with a depth of over 70mm. The P4D, however, was able to demonstrate excellent chip evacuation even in deep-hole with no step processing required, improving performance with the reduction of machining time by 45% per hole.

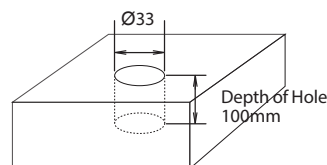
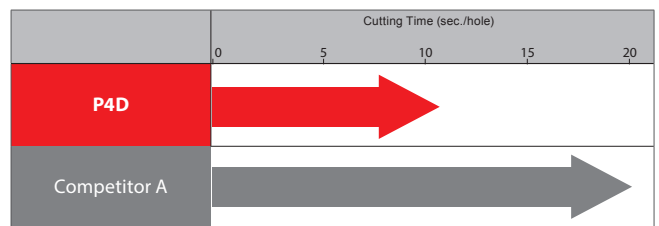

Processing data

Drilling with long tool life in high-hardened material (P3D)

Tool	P3D2100FS25M07 (Ø25)	Competitor's Indexable Drill
Insert Grade	XCMT073106ER-DM (XP9020)	Coated Carbide Insert
Work Material	SKD61 (50HRC)	
Cutting Speed	80m/min (1.200min ⁻¹)	
Feed	100mm/min (0,08mm/rev)	
Depth of Hole	63mm (Blind)	
Coolant	Water Soluble (Internal)	
Machine	Horizontal Machining Center	

The competitor product exhibited chipping of the center blade after processing 30 holes in a high hardness material of HRC50. The P3D, on the other hand, was able to continue processing even after 50 holes with minimal wear.

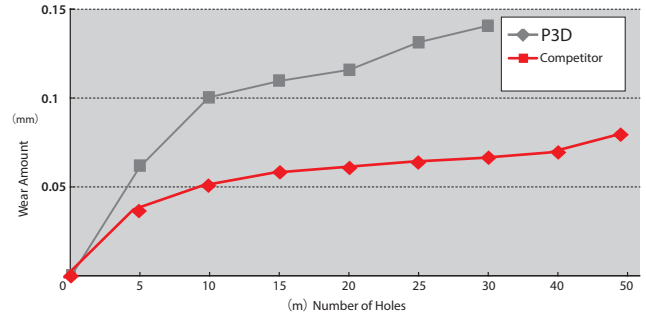
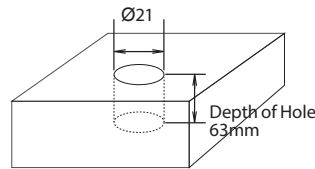

Wear comparison

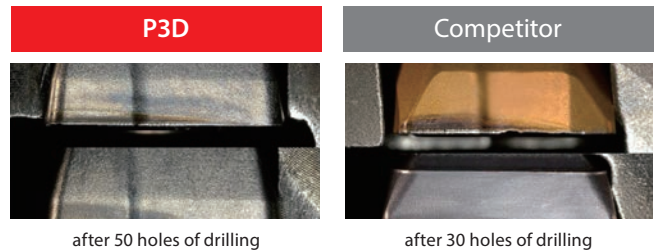

Turning of building component (P4D)

Tool	P4D2200FS25M07 (Ø22)	Competitor's Indexable Drill
Insert Grade	XCMT073106ER-DM (XP9020)	Coated Carbide Insert
Work Material	SCM415	
Cutting Speed	104m/min (1.500min ⁻¹)	
Feed	300mm/min (0,2mm/rev)	
Depth of Hole	70mm (Through)	
Coolant	Water Soluble (Internal)	
Machine	Horizontal NC Lathe	

The insert of the competitor tool exhibited chipping during the processing of a 70mm deep-hole turning application while the P4D was able to continue processing with minimal wear shown.

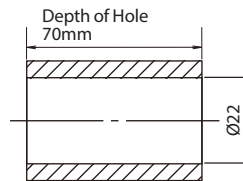
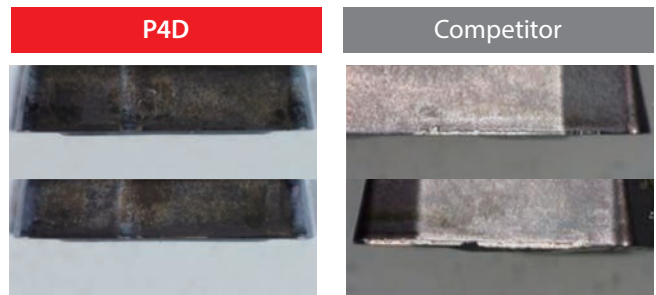

High efficiency drilling in S50C (P5D)

Tool	P5D2700FS32M08 (Ø27)
Insert Grade	XCMT083508ER-DM (XP9020)
Work Material	S50C
Cutting Speed	150m/min (1,800min ⁻¹)
Feed	216mm/min (0.12mm/rev)
Depth of Hole	120mm (Through)
Coolant	Water Soluble
Machine	Horizontal Machining Center

High efficiency can be achieved even when drilling 5xD deep holes. With stable performance, tool life can be prolonged.

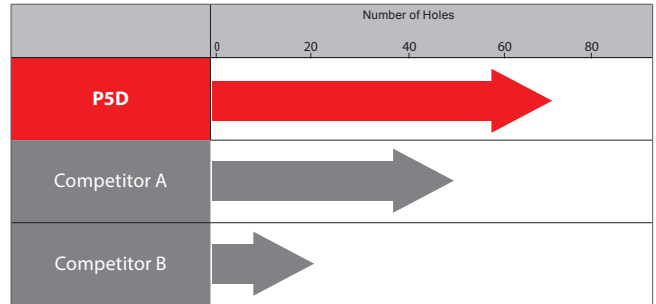

Wear comparison after drilling 40 holes

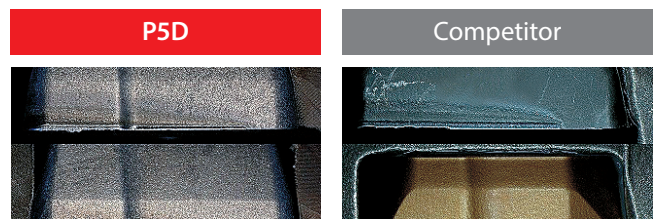

Stable performance even in stainless steel (P5D)

Tool	P5D2700FS32M08 (Ø27)
Insert Grade	XCMT083508ER-DM (XP9020)
Work Material	SUS304
Cutting Speed	120m/min (1,400min ⁻¹)
Feed	140mm/min (0,1mm/rev)
Depth of Hole	120mm (Through)
Coolant	Water Soluble
Machine	Horizontal Machining Center

The P5D is able to achieve great chip evacuation and stable performance even in SUS304, where chip packing is a common problem.

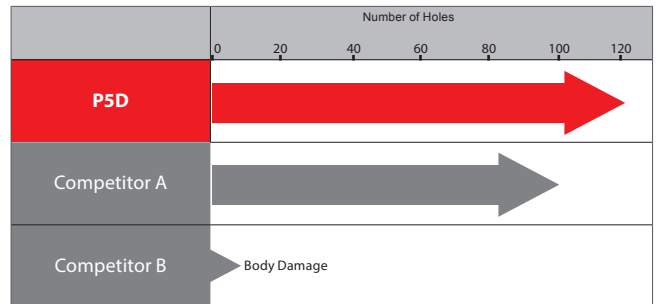

Wear comparison after drilling 100 holes



Drilling with long tool life in ADC12 (P5D)

Tool	P5D2500FS32M8 (Ø25)
Insert Grade	XCMT083508ER-DN (CK110)
Work Material	ADC12
Cutting Speed	250m/min (3.185min ⁻¹)
Feed	320mm/min (0,1mm/rev)
Depth of Hole	100mm (Blind)
Coolant	Water Soluble
Machine	Horizontal Machining Center

Long tool life was achieved in machining ADC12 by using inserts for aluminium alloy and non-ferrous materials.

Wear comparison after drilling 200 holes

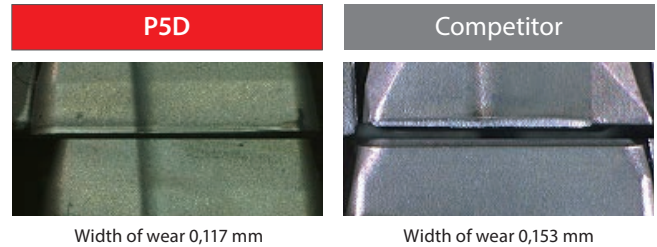

Drilling with long tool life in FC250 (P5D)

Tool	P5D2500FS32M08 (Ø25)
Insert Grade	XCMT083508ER-DR (XP1010)
Work Material	FC250
Cutting Speed	150m/min (1,910min ⁻¹)
Feed	200mm/min (0.1mm/rev)
Depth of Hole	100mm (Blind)
Coolant	Water Soluble
Machine	Horizontal Machining Center

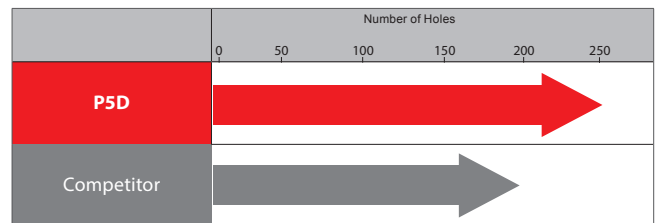

P5D achieved stable drilling of 250holes, which was over 1,3 times, versus the competition.

Wear comparison after drilling 150 holes

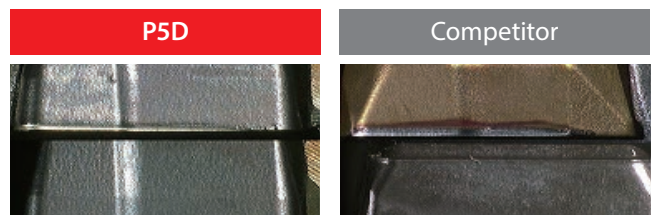

Stable performance even in SUS304 (P5D)

Tool	P5D1500FS20M04 (Ø15)	Competitor A	Competitor B
Insert Grade	XCMT042204ER-DM (XP9020)	Coated Carbide Insert	
Work Material	SUS304		
Cutting Speed	120m/min (2.550min ⁻¹)		
Feed	150mm/min (0,06mm/rev)		
Depth of Hole	75mm (Blind)		
Coolant	Water Soluble (internal)		
Machine	Horizontal Machining Center		

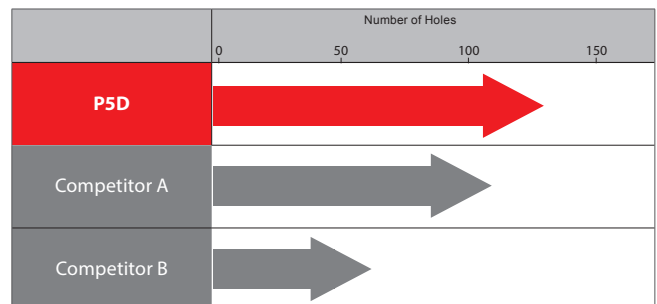

Wear comparison after 9m of drilling



P2D

Drilling | Indexable | Body

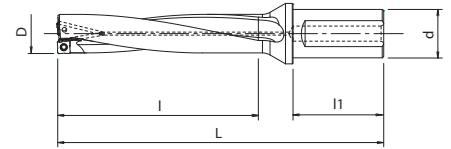

- Indexable drill with internal coolant
- Up to 2xD
- 3 different insert grades available
- 77 sizes

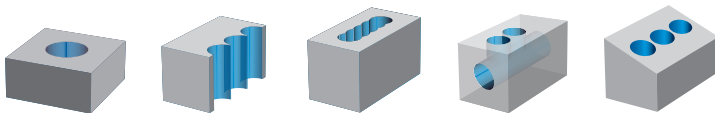

Drilling | Indexable

Body

EDP	Designation	D		Applicable inserts type	L	l	l1	d	Price
7803180	P2D1200FS20M03	12	NEW	XCMT03...	87	24	50	20	
7803181	P2D1250FS20M03	12,5	NEW	XCMT03...	88	25	50	20	
7803182	P2D1300FS20M03	13	NEW	XCMT03...	89	26	50	20	
7803183	P2D1350FS20M03	13,5	NEW	XCMT03...	90	27	50	20	
7803184	P2D1400FS20M03	14	NEW	XCMT03...	91	28	50	20	
7803185	P2D1450FS20M03	14,5	NEW	XCMT03...	92	29	50	20	
7803117	P2D1500FS20M04	15		XCMT04...	95	30	50	20	
7803118	P2D1550FS20M04	15,5		XCMT04...	96	31	50	20	
7803119	P2D1600FS20M04	16		XCMT04...	97	32	50	20	
7803120	P2D1650FS20M04	16,5		XCMT04...	98	33	50	20	
7803121	P2D1700FS20M05	17		XCMT05...	102	34	50	20	
7803122	P2D1750FS20M05	17,5		XCMT05...	103	35	50	20	
7803190	P2D1750FS25M05	17,5		XCMT05...	109	35	56	25	
7803123	P2D1800FS25M05	18		XCMT05...	110	36	56	25	
7803124	P2D1850FS25M05	18,5		XCMT05...	111	37	56	25	
7803125	P2D1900FS25M06	19		XCMT06...	112	38	56	25	
7803126	P2D1950FS25M06	19,5		XCMT06...	113	39	56	25	
7803127	P2D2000FS25M06	20		XCMT06...	114	40	56	25	
7803128	P2D2050FS25M06	20,5		XCMT06...	115	41	56	25	
7803129	P2D2100FS25M07	21		XCMT07...	121	42	56	25	
7803130	P2D2150FS25M07	21,5		XCMT07...	122	43	56	25	
7803131	P2D2200FS25M07	22		XCMT07...	123	44	56	25	
7803132	P2D2250FS25M07	22,5		XCMT07...	124	45	56	25	
7803133	P2D2300FS25M07	23		XCMT07...	125	46	56	25	
7803191	P2D2350FS25M07	23,5		XCMT07...	126	47	56	25	
7803134	P2D2350FS32M07	23,5		XCMT07...	130	47	60	32	
7803192	P2D2400FS25M07	24		XCMT07...	127	48	56	25	
7803135	P2D2400FS32M07	24		XCMT07...	131	48	60	32	
7803193	P2D2450FS25M07	24,5		XCMT07...	128	49	56	25	
7803136	P2D2450FS32M07	24,5		XCMT07...	132	49	60	32	
7803194	P2D2500FS25M08	25		XCMT08...	129	50	56	25	
7803137	P2D2500FS32M08	25		XCMT08...	133	50	60	32	
7803195	P2D2550FS25M08	25,5		XCMT08...	130	51	56	25	
7803138	P2D2550FS32M08	25,5		XCMT08...	134	51	60	32	
7803139	P2D2600FS32M08	26		XCMT08...	135	52	60	32	
7803140	P2D2650FS32M08	26,5		XCMT08...	136	53	60	32	
7803141	P2D2700FS32M08	27		XCMT08...	137	54	60	32	
7803142	P2D2800FS32M08	28		XCMT08...	139	56	60	32	
7803143	P2D2850FS32M08	28,5		XCMT08...	140	57	60	32	
7803144	P2D2900FS32M09	29		XCMT09...	141	58	60	32	
7803145	P2D3000FS32M09	30		XCMT09...	143	60	60	32	
7803146	P2D3100FS32M09	31		XCMT09...	145	62	60	32	
7803196	P2D3100FS40M09	31		XCMT09...	155	62	70	40	
7803147	P2D3200FS32M09	32		XCMT09...	147	64	60	32	
7803197	P2D3200FS40M09	32		XCMT09...	157	64	70	40	
7803148	P2D3300FS40M09	33		XCMT09...	159	66	70	40	
7803149	P2D3350FS40M09	33,5		XCMT09...	160	67	70	40	
7803150	P2D3400FS40M10	34		XCMT10...	161	68	70	40	
7803151	P2D3500FS40M10	35		XCMT10...	163	70	70	40	
7803152	P2D3600FS40M10	36		XCMT10...	165	72	70	40	
7803153	P2D3700FS40M10	37		XCMT10...	167	74	70	40	
7803154	P2D3800FS40M10	38		XCMT10...	169	76	70	40	
7803155	P2D3900FS40M12	39		XCMT12...	178	78	70	40	
7803156	P2D4000FS40M12	40		XCMT12...	180	80	70	40	

P3D

Drilling | Indexable | Body

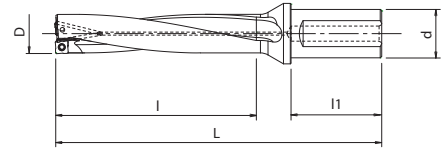

- Indexable drill with internal coolant
- Up to 3xD
- 3 different insert grades available
- 88 sizes

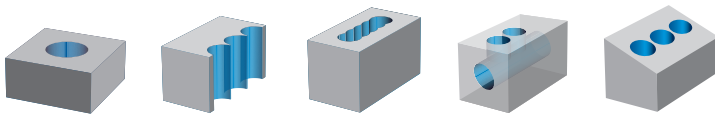

Drilling | Indexable

Body

EDP	Designation	D	Applicable inserts type	L	I	l1	d	Price
7803210	P3D1200FS20M03	12	XCMT03...	99	36	50	20	
7803211	P3D1250FS20M03	12,5	XCMT03...	100,5	37,5	50	20	
7803212	P3D1270FS20M03	12,7	XCMT03...	101,1	38,1	50	20	
7803213	P3D1300FS20M03	13	XCMT03...	102	39	50	20	
7803214	P3D1350FS20M03	13,5	XCMT03...	103,5	40,5	50	20	
7803215	P3D1400FS20M03	14	XCMT03...	105	42	50	20	
7803216	P3D1450FS20M03	14,5	XCMT03...	106,5	43,5	50	20	
7803217	P3D1500FS20M04	15	XCMT04...	110	45	50	20	
7803218	P3D1550FS20M04	15,5	XCMT04...	112	47	50	20	
7803219	P3D1600FS20M04	16	XCMT04...	113	48	50	20	
7803220	P3D1650FS20M04	16,5	XCMT04...	115	50	50	20	
7803221	P3D1700FS20M05	17	XCMT05...	119	51	50	20	
7803222	P3D1750FS20M05	17,5	XCMT05...	121	53	50	20	
7803290	P3D1750FS25M05	17,5	XCMT05...	127	53	56	25	
7803223	P3D1800FS25M05	18	XCMT05...	128	54	56	25	
7803224	P3D1850FS25M05	18,5	XCMT05...	130	56	56	25	
7803225	P3D1900FS25M06	19	XCMT06...	131	57	56	25	
7803226	P3D1950FS25M06	19,5	XCMT06...	133	59	56	25	
7803227	P3D2000FS25M06	20	XCMT06...	134	60	56	25	
7803228	P3D2050FS25M06	20,5	XCMT06...	136	62	56	25	
7803229	P3D2100FS25M07	21	XCMT07...	142	63	56	25	
7803230	P3D2150FS25M07	21,5	XCMT07...	144	65	56	25	
7803231	P3D2200FS25M07	22	XCMT07...	145	66	56	25	
7803232	P3D2250FS25M07	22,5	XCMT07...	147	68	56	25	
7803233	P3D2300FS25M07	23	XCMT07...	148	69	56	25	
7803291	P3D2350FS25M07	23,5	XCMT07...	150	71	56	25	
7803234	P3D2350FS32M07	23,5	XCMT07...	154	71	60	32	
7803292	P3D2400FS25M07	24	XCMT07...	151	72	56	25	
7803235	P3D2400FS32M07	24	XCMT07...	155	72	60	32	
7803293	P3D2450FS25M07	24,5	XCMT07...	153	74	56	25	
7803236	P3D2450FS32M07	24,5	XCMT07...	157	74	60	32	
7803294	P3D2500FS25M08	25	XCMT08...	154	75	56	25	
7803237	P3D2500FS32M08	25	XCMT08...	158	75	60	32	
7803295	P3D2550FS25M08	25,5	XCMT08...	156	77	56	25	
7803238	P3D2550FS32M08	25,5	XCMT08...	160	77	60	32	
7803239	P3D2600FS32M08	26	XCMT08...	161	78	60	32	
7803240	P3D2650FS32M08	26,5	XCMT08...	163	80	60	32	
7803241	P3D2700FS32M08	27	XCMT08...	164	81	60	32	
7803300	P3D2750FS32M08	27,5	XCMT08...	166	83	60	32	
7803242	P3D2800FS32M08	28	XCMT08...	167	84	60	32	
7803243	P3D2850FS32M08	28,5	XCMT08...	169	86	60	32	
7803244	P3D2900FS32M09	29	XCMT09...	170	87	60	32	
7803301	P3D2950FS32M09	29,5	XCMT09...	172	89	60	32	
7803245	P3D3000FS32M09	30	XCMT09...	173	90	60	32	
7803302	P3D3050FS32M09	30,5	XCMT09...	175	92	60	32	
7803246	P3D3100FS32M09	31	XCMT09...	176	93	60	32	
7803296	P3D3100FS40M09	31	XCMT09...	186	93	70	40	
7803303	P3D3150FS32M09	31,5	XCMT09...	178	95	60	32	
7803247	P3D3200FS32M09	32	XCMT09...	179	96	60	32	
7803297	P3D3200FS40M09	32	XCMT09...	189	96	70	40	
7803304	P3D3250FS40M09	32,5	XCMT09...	191	98	70	40	
7803248	P3D3300FS40M09	33	XCMT09...	192	99	70	40	
7803249	P3D3350FS40M09	33,5	XCMT09...	194	101	70	40	
7803250	P3D3400FS40M10	34	XCMT10...	195	102	70	40	

P3D

Drilling | Indexable | Body

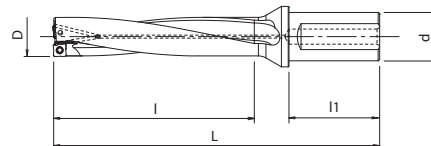

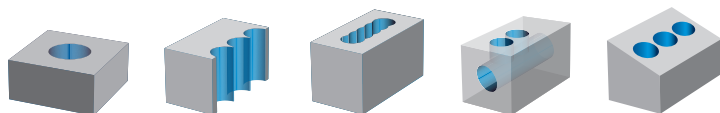

- Indexable drill with internal coolant
- Up to 3xD
- 3 different insert grades available
- 88 sizes



EDP	Designation	D	Applicable inserts type	L	I	l1	d	Price
7803305	P3D3450FS40M10	34,5	XCMT10...	197	104	70	40	
7803251	P3D3500FS40M10	35	XCMT10...	198	105	70	40	
7803306	P3D3550FS40M10	35,5	XCMT10...	200	107	70	40	
7803252	P3D3600FS40M10	36	XCMT10...	201	108	70	40	
7803253	P3D3700FS40M10	37	XCMT10...	204	111	70	40	
7803307	P3D3750FS40M10	37,5	XCMT10...	206	113	70	40	
7803254	P3D3800FS40M10	38	XCMT10...	207	114	70	40	
7803255	P3D3900FS40M12	39	XCMT12...	217	117	70	40	
7803256	P3D4000FS40M12	40	XCMT12...	220	120	70	40	
7803308	P3D4050FS40M12	40,5	XCMT12...	222	122	70	40	
7803257	P3D4100FS40M12	41	XCMT12...	223	123	70	40	
7803258	P3D4200FS40M12	42	XCMT12...	226	126	70	40	
7803259	P3D4300FS40M12	43	XCMT12...	229	129	70	40	
7803260	P3D4400FS40M12	44	XCMT12...	232	132	70	40	
7803261	P3D4500FS40M13	45	XCMT13...	235	135	70	40	
7803262	P3D4600FS40M13	46	XCMT13...	238	138	70	40	
7803263	P3D4700FS40M13	47	XCMT13...	241	141	70	40	
7803264	P3D4800FS40M13	48	XCMT13...	244	144	70	40	
7803265	P3D4900FS40M13	49	XCMT13...	247	147	70	40	
7803266	P3D5000FS40M14	50	XCMT14...	250	150	70	40	
7803309	P3D5050FS40M14	50,5	XCMT14...	252	152	70	40	
7803267	P3D5100FS40M14	51	XCMT14...	253	153	70	40	
7803268	P3D5200FS40M14	52	XCMT14...	256	156	70	40	
7803269	P3D5300FS40M14	53	XCMT14...	259	159	70	40	
7803270	P3D5400FS40M14	54	XCMT14...	262	162	70	40	
7803271	P3D5500FS40M14	55	XCMT14...	265	165	70	40	
7803272	P3D5600FS40M14	56	XCMT14...	268	168	70	40	
7803273	P3D5700FS40M16	57	XCMT16...	271	171	70	40	
7803274	P3D5800FS40M16	58	XCMT16...	274	174	70	40	
7803275	P3D5900FS40M16	59	XCMT16...	277	177	70	40	
7803276	P3D6000FS40M16	60	XCMT16...	280	180	70	40	
7803277	P3D6100FS40M16	61	XCMT16...	283	183	70	40	
7803278	P3D6200FS40M16	62	XCMT16...	286	186	70	40	
7803279	P3D6300FS40M16	63	XCMT16...	289	189	70	40	

Accessories & spare parts

Applicable drill Ø	 Clamping screw		 Wrench	
	EDP	Designation	EDP	Designation
Ø 12 - 14,5	7808096	FS18536P	7808223	6IP-D (Torx 6IP)
Ø 15 - 18,5	7808139	FS20543P	7808223	6IP-D (Torx 6IP)
Ø 19 - 20,5	7808138	FS22550P	7808224	7IP-D (Torx 7IP)
Ø 21 - 24,5	7808136	FS25560P	7808225	8IP-D (Torx 8IP)
Ø 25 - 33,5	7808135	FS30570P	7808226	9IP-D (Torx 9IP)
Ø 34 - 44	7808137	FS35586P	7808228	15IP-D (Torx 15IP)
Ø 45 - 63	7808114	FS45510P	7808229	20IP-D (Torx 20IP)

Drilling | Indexable



Body

P4D

Drilling | Indexable | Body

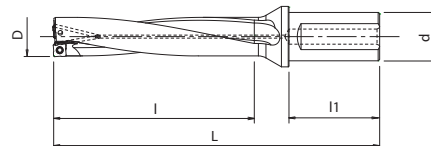

- Indexable drill with internal coolant
- Up to 4xD
- 3 different insert grades available
- 77 sizes

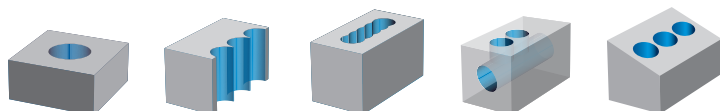

EDP	Designation	D	Applicable inserts type	L	I	l1	d	Price
7803311	P4D1200FS20M03	12	XCMT03...	111	48	50	20	
7803312	P4D1250FS20M03	12,5	XCMT03...	113	50	50	20	
7803313	P4D1300FS20M03	13	XCMT03...	115	52	50	20	
7803314	P4D1350FS20M03	13,5	XCMT03...	117	54	50	20	
7803315	P4D1400FS20M03	14	XCMT03...	119	56	50	20	
7803316	P4D1450FS20M03	14,5	XCMT03...	121	58	50	20	
7803317	P4D1500FS20M04	15	XCMT04...	125	60	50	20	
7803318	P4D1550FS20M04	15,5	XCMT04...	127	62	50	20	
7803319	P4D1600FS20M04	16	XCMT04...	129	64	50	20	
7803320	P4D1650FS20M04	16,5	XCMT04...	131	66	50	20	
7803321	P4D1700FS20M05	17	XCMT05...	136	68	50	20	
7803322	P4D1750FS20M05	17,5	XCMT05...	138	70	50	20	
7803390	P4D1750FS25M05	17,5	XCMT05...	144	70	56	25	
7803323	P4D1800FS25M05	18	XCMT05...	146	72	56	25	
7803324	P4D1850FS25M05	18,5	XCMT05...	148	74	56	25	
7803325	P4D1900FS25M06	19	XCMT06...	150	76	56	25	
7803326	P4D1950FS25M06	19,5	XCMT06...	152	78	56	25	
7803327	P4D2000FS25M06	20	XCMT06...	154	80	56	25	
7803328	P4D2050FS25M06	20,5	XCMT06...	156	82	56	25	
7803329	P4D2100FS25M07	21	XCMT07...	163	84	56	25	
7803330	P4D2150FS25M07	21,5	XCMT07...	165	86	56	25	
7803331	P4D2200FS25M07	22	XCMT07...	167	88	56	25	
7803332	P4D2250FS25M07	22,5	XCMT07...	169	90	56	25	
7803333	P4D2300FS25M07	23	XCMT07...	171	92	56	25	
7803391	P4D2350FS25M07	23,5	XCMT07...	173	94	56	25	
7803334	P4D2350FS32M07	23,5	XCMT07...	177	94	60	32	
7803392	P4D2400FS25M07	24	XCMT07...	175	96	56	25	
7803335	P4D2400FS32M07	24	XCMT07...	179	96	60	32	
7803393	P4D2450FS25M07	24,5	XCMT07...	177	98	56	25	
7803336	P4D2450FS32M07	24,5	XCMT07...	181	98	60	32	
7803394	P4D2500FS25M08	25	XCMT08...	179	100	56	25	
7803337	P4D2500FS32M08	25	XCMT08...	183	100	60	32	
7803395	P4D2550FS25M08	25,5	XCMT08...	181	102	56	25	
7803338	P4D2550FS32M08	25,5	XCMT08...	185	102	60	32	
7803339	P4D2600FS32M08	26	XCMT08...	187	104	60	32	
7803340	P4D2650FS32M08	26,5	XCMT08...	189	106	60	32	
7803341	P4D2700FS32M08	27	XCMT08...	191	108	60	32	
7803342	P4D2800FS32M08	28	XCMT08...	195	112	60	32	
7803343	P4D2850FS32M08	28,5	XCMT08...	197	114	60	32	
7803344	P4D2900FS32M09	29	XCMT09...	199	116	60	32	
7803345	P4D3000FS32M09	30	XCMT09...	203	120	60	32	
7803346	P4D3100FS32M09	31	XCMT09...	207	124	60	32	
7803396	P4D3100FS40M09	31	XCMT09...	217	124	70	40	
7803347	P4D3200FS32M09	32	XCMT09...	211	128	60	32	
7803397	P4D3200FS40M09	32	XCMT09...	221	128	70	32	
7803348	P4D3300FS40M09	33	XCMT09...	225	132	70	40	
7803349	P4D3350FS40M09	33,5	XCMT09...	227	134	70	40	
7803350	P4D3400FS40M10	34	XCMT10...	229	136	70	40	
7803351	P4D3500FS40M10	35	XCMT10...	233	140	70	40	
7803352	P4D3600FS40M10	36	XCMT10...	237	144	70	40	
7803353	P4D3700FS40M10	37	XCMT10...	241	148	70	40	
7803354	P4D3800FS40M10	38	XCMT10...	245	152	70	40	
7803355	P4D3900FS40M12	39	XCMT12...	256	156	70	40	
7803356	P4D4000FS40M12	40	XCMT12...	260	160	70	40	

Drilling | Indexable

Body

P5D

Drilling | Indexable | Body

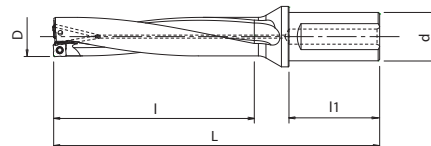

- Indexable drill with internal coolant
- Up to 5xD
- 3 different insert grades available
- 77 sizes

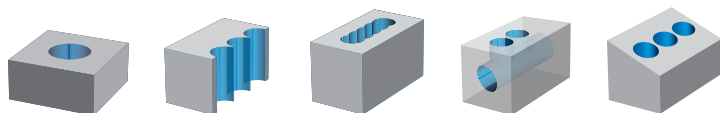

EDP	Designation	D	Applicable inserts type	L	I	I1	d	Price
7802780	P5D1200FS20M03	12	XCMT03...	123	60	50	20	
7802781	P5D1250FS20M03	12,5	XCMT03...	125,5	62,5	50	20	
7802782	P5D1300FS20M03	13	XCMT03...	128	65	50	20	
7802783	P5D1350FS20M03	13,5	XCMT03...	130,5	67,5	50	20	
7802784	P5D1400FS20M03	14	XCMT03...	133	70	50	20	
7802785	P5D1450FS20M03	14,5	XCMT03...	135,5	72,5	50	20	
7802717	P5D1500FS20M04	15	XCMT04...	140	75	50	20	
7802718	P5D1550FS20M04	15,5	XCMT04...	143	78	50	20	
7802719	P5D1600FS20M04	16	XCMT04...	145	80	50	20	
7802720	P5D1650FS20M04	16,5	XCMT04...	148	83	50	20	
7802721	P5D1700FS20M05	17	XCMT05...	153	85	50	20	
7802722	P5D1750FS20M05	17,5	XCMT05...	156	88	50	20	
7802790	P5D1750FS25M05	17,5	XCMT05...	162	88	56	25	
7802723	P5D1800FS25M05	18	XCMT05...	164	90	56	25	
7802724	P5D1850FS25M05	18,5	XCMT05...	167	93	56	25	
7802725	P5D1900FS25M06	19	XCMT06...	169	95	56	25	
7802726	P5D1950FS25M06	19,5	XCMT06...	172	98	56	25	
7802727	P5D2000FS25M06	20	XCMT06...	174	100	56	25	
7802728	P5D2050FS25M06	20,5	XCMT06...	177	103	56	25	
7802729	P5D2100FS25M07	21	XCMT07...	184	105	56	25	
7802730	P5D2150FS25M07	21,5	XCMT07...	187	108	56	25	
7802731	P5D2200FS25M07	22	XCMT07...	189	110	56	25	
7802732	P5D2250FS25M07	22,5	XCMT07...	192	113	56	25	
7802733	P5D2300FS25M07	23	XCMT07...	194	115	56	25	
7802791	P5D2350FS25M07	23,5	XCMT07...	197	118	56	25	
7802734	P5D2350FS32M07	23,5	XCMT07...	201	118	60	32	
7802792	P5D2400FS25M07	24	XCMT07...	199	120	56	25	
7802735	P5D2400FS32M07	24	XCMT07...	203	120	60	32	
7802793	P5D2450FS25M07	24,5	XCMT07...	202	123	56	25	
7802736	P5D2450FS32M07	24,5	XCMT07...	206	123	60	32	
7802794	P5D2500FS25M08	25	XCMT08...	204	125	56	25	
7802737	P5D2500FS32M08	25	XCMT08...	208	125	60	32	
7802795	P5D2550FS25M08	25,5	XCMT08...	207	128	56	25	
7802738	P5D2550FS32M08	25,5	XCMT08...	211	128	60	32	
7802739	P5D2600FS32M08	26	XCMT08...	213	130	60	32	
7802740	P5D2650FS32M08	26,5	XCMT08...	216	133	60	32	
7802741	P5D2700FS32M08	27	XCMT08...	218	135	60	32	
7802742	P5D2800FS32M08	28	XCMT08...	223	140	60	32	
7802743	P5D2850FS32M08	28,5	XCMT08...	226	143	60	32	
7802744	P5D2900FS32M09	29	XCMT09...	228	145	60	32	
7802745	P5D3000FS32M09	30	XCMT09...	233	150	60	32	
7802746	P5D3100FS32M09	31	XCMT09...	238	155	60	32	
7802796	P5D3100FS40M09	31	XCMT09...	248	155	70	40	
7802747	P5D3200FS32M09	32	XCMT09...	243	160	60	32	
7802797	P5D3200FS40M09	32	XCMT09...	253	160	70	40	
7802748	P5D3300FS40M09	33	XCMT09...	258	165	70	40	
7802749	P5D3350FS40M09	33,5	XCMT09...	261	168	70	40	
7802750	P5D3400FS40M10	34	XCMT10...	263	170	70	40	
7802751	P5D3500FS40M10	35	XCMT10...	268	175	70	40	
7802752	P5D3600FS40M10	36	XCMT10...	273	180	70	40	
7802753	P5D3700FS40M10	37	XCMT10...	278	185	70	40	
7802754	P5D3800FS40M10	38	XCMT10...	283	190	70	40	
7802755	P5D3900FS40M12	39	XCMT12...	295	195	70	40	
7802756	P5D4000FS40M12	40	XCMT12...	300	200	70	40	

Drilling | Indexable

Body

P2D • P3D • P4D • P5D INSERTS

Drilling | Indexable | Inserts & Heads

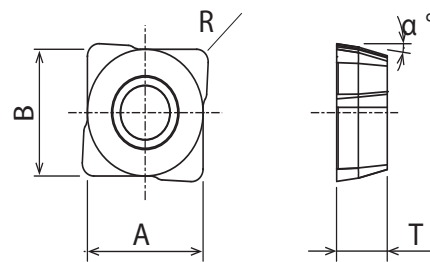

- Applicable inserts for PD drill



EDP	Designation	z	A x B	T	α	R	Grade	P		M		K		N		S		H		Applicable body Ø	Price
								dry	⊖	dry	⊖	GG	GGG	dry	⊖	dry	⊖	dry	⊖		
7823098	XCMT031904ER-DM	2	6,1x4,5	1,9	8	0,4	XP9020	●	●	●	●	●	●	●	●	●	●	●	●	Ø12 - 14,5	
7823064	XCMT042204ER-DM	4	5	2,2	8	0,4	XP9020	●	●	●	●	●	●	●	●	●	●	●	●	Ø15 - 16,5	
7823065	XCMT052404ER-DM	4	5,83	2,4	8	0,4	XP9020	●	●	●	●	●	●	●	●	●	●	●	●	Ø17 - 18,5	
7823066	XCMT062706ER-DM	4	6,46	2,7	8	0,6	XP9020	●	●	●	●	●	●	●	●	●	●	●	●	Ø19 - 20,5	
7823067	XCMT073106ER-DM	4	7,11	3,1	8	0,6	XP9020	●	●	●	●	●	●	●	●	●	●	●	●	Ø21 - 24,5	
7823068	XCMT083508ER-DM	4	8,36	3,5	8	0,8	XP9020	●	●	●	●	●	●	●	●	●	●	●	●	Ø25 - 28,5	
7823069	XCMT094008ER-DM	4	9,62	4	8	0,8	XP9020	●	●	●	●	●	●	●	●	●	●	●	●	Ø29 - 33,5	
7823097	XCMT104608ER-DM	4	10,89	4,6	8	0,8	XP9020	●	●	●	●	●	●	●	●	●	●	●	●	Ø34 - 38	
7823071	XCMT125010ER-DM	4	12,57	5	8	1	XP9020	●	●	●	●	●	●	●	●	●	●	●	●	Ø39 - 44	
7823072	XCMT135212ER-DM	4	14,05	5,2	8	1,2	XP9020	●	●	●	●	●	●	●	●	●	●	●	●	Ø45 - 49	
7823073	XCMT145612ER-DM	4	15,58	5,6	8	1,2	XP9020	●	●	●	●	●	●	●	●	●	●	●	●	Ø50 - 56	
7823075	XCMT165912ER-DM	4	17,28	5,9	8	1,2	XP9020	●	●	●	●	●	●	●	●	●	●	●	●	Ø57 - 63	
7823163	XCMT031904ER-DR	2	6,1x4,5	1,9	8	0,4	XP1010	○	○	○	○	○	○	○	○	○	○	○	○	Ø12 - 14,5	
7823164	XCMT042204ER-DR	4	5	2,2	8	0,4	XP1010	○	○	○	○	○	○	○	○	○	○	○	○	Ø15 - 16,5	
7823165	XCMT052404ER-DR	4	5,83	2,4	8	0,4	XP1010	○	○	○	○	○	○	○	○	○	○	○	○	Ø17 - 18,5	
7823166	XCMT062706ER-DR	4	6,46	2,7	8	0,6	XP1010	○	○	○	○	○	○	○	○	○	○	○	○	Ø19 - 20,5	
7823167	XCMT073106ER-DR	4	7,11	3,1	8	0,6	XP1010	○	○	○	○	○	○	○	○	○	○	○	○	Ø21 - 24,5	
7823168	XCMT083508ER-DR	4	8,36	3,5	8	0,8	XP1010	○	○	○	○	○	○	○	○	○	○	○	○	Ø25 - 28,5	
7823169	XCMT094008ER-DR	4	9,62	4	8	0,8	XP1010	○	○	○	○	○	○	○	○	○	○	○	○	Ø29 - 33,5	
7823197	XCMT104608ER-DR	4	10,89	4,6	8	0,8	XP1010	○	○	○	○	○	○	○	○	○	○	○	○	Ø34 - 38	
7823171	XCMT125010ER-DR	4	12,57	5	8	1	XP1010	○	○	○	○	○	○	○	○	○	○	○	○	Ø39 - 44	
7823172	XCMT135212ER-DR	4	14,05	5,2	8	1,2	XP1010	○	○	○	○	○	○	○	○	○	○	○	○	Ø45 - 49	
7823173	XCMT145612ER-DR	4	15,58	5,6	8	1,2	XP1010	○	○	○	○	○	○	○	○	○	○	○	○	Ø50 - 56	
7823175	XCMT165912ER-DR	4	17,28	5,9	8	1,2	XP1010	○	○	○	○	○	○	○	○	○	○	○	○	Ø57 - 63	
7823263	XCMT031904ER-DN	2	6,1x4,5	1,9	8	0,4	CK110							●						Ø12 - 14,5	
7823264	XCMT042204ER-DN	4	5	2,2	8	0,4	CK110							●						Ø15 - 16,5	
7823265	XCMT052404ER-DN	4	5,83	2,4	8	0,4	CK110							●						Ø17 - 18,5	
7823266	XCMT062706ER-DN	4	6,46	2,7	8	0,6	CK110							●						Ø19 - 20,5	
7823267	XCMT073106ER-DN	4	7,11	3,1	8	0,6	CK110							●						Ø21 - 24,5	
7823268	XCMT083508ER-DN	4	8,36	3,5	8	0,8	CK110							●						Ø25 - 28,5	
7823269	XCMT094008ER-DN	4	9,62	4	8	0,8	CK110							●						Ø29 - 33,5	
7823297	XCMT104608ER-DN	4	10,89	4,6	8	0,8	CK110							●						Ø34 - 38	
7823271	XCMT125010ER-DN	4	12,57	5	8	1	CK110							●						Ø39 - 44	
7823272	XCMT135212ER-DN	4	14,05	5,2	8	1,2	CK110							●						Ø45 - 49	
7823273	XCMT145612ER-DN	4	15,58	5,6	8	1,2	CK110							●						Ø50 - 56	
7823275	XCMT165912ER-DN	4	17,28	5,9	8	1,2	CK110							●						Ø57 - 63	

Drilling | Indexable

Inserts & Heads

CUTTING CONDITIONS

Drilling | Indexable | Cutting conditions

P2D & P3D

Work Material	Tensile Strength/Hardness	Vc (m/min)	Feed Rate (mm/rev)								
			ø12~ø14.5	ø15~ø16.5	ø17~ø18.5	ø19~ø20.5	ø21~ø24.5	ø25~ø28.5	ø29~ø33.5	ø34~ø63	
P	Mild Steel-Carbon Steel (S5400-S10C)	~180HB	200 (150~250)	0.06 (0.04~0.08)	0.06 (0.04~0.1)	0.06 (0.04~0.1)	0.07 (0.04~0.1)	0.08 (0.04~0.12)	0.08 (0.04~0.12)	0.1 (0.05~0.15)	0.1 (0.05~0.18)
	Carbon Steel-Alloy Steel (S50C-SCM440)	~280HB	150 (100~220)	0.08 (0.04~0.12)	0.08 (0.04~0.14)	0.09 (0.04~0.16)	0.1 (0.04~0.18)	0.14 (0.04~0.2)	0.18 (0.06~0.25)	0.2 (0.08~0.3)	0.2 (0.08~0.35)
M	Die Steel (SKD11-SKD61)	~280HB	120 (80~180)	0.06 (0.04~0.1)	0.06 (0.04~0.1)	0.07 (0.04~0.1)	0.08 (0.04~0.12)	0.12 (0.04~0.15)	0.14 (0.06~0.2)	0.18 (0.08~0.25)	0.18 (0.08~0.25)
	Stainless Steel (SUS304-SUS420)	~250HB	130 (80~180)	0.07 (0.04~0.1)	0.07 (0.04~0.1)	0.08 (0.04~0.1)	0.09 (0.04~0.12)	0.1 (0.04~0.15)	0.13 (0.06~0.2)	0.15 (0.08~0.25)	0.15 (0.08~0.25)
K	Cast Iron (FC250)	~350N/mm ²	200 (150~280)	0.08 (0.04~0.14)	0.08 (0.04~0.14)	0.1 (0.04~0.16)	0.12 (0.04~0.2)	0.16 (0.08~0.25)	0.2 (0.06~0.3)	0.2 (0.08~0.3)	0.2 (0.08~0.35)
	Ductile Cast Iron (FCD400)	~800N/mm ²	160 (100~220)	0.08 (0.04~0.1)	0.08 (0.04~0.12)	0.09 (0.04~0.14)	0.1 (0.04~0.18)	0.14 (0.04~0.2)	0.18 (0.06~0.25)	0.18 (0.08~0.25)	0.18 (0.08~0.25)
N	Alluminium Alloy	~13%Si	200 (100~800)	0.08 (0.04~0.12)	0.08 (0.04~0.12)	0.1 (0.04~0.16)	0.12 (0.04~0.2)	0.16 (0.04~0.25)	0.2 (0.06~0.3)	0.2 (0.08~0.3)	0.2 (0.08~0.3)
S	Heat Resistant Alloy (Wet) (Inconel 718)	-	30 (15~50)	0.04 (0.02~0.06)	0.04 (0.02~0.06)	0.05 (0.03~0.06)	0.05 (0.03~0.06)	0.06 (0.04~0.08)	0.08 (0.06~0.1)	0.1 (0.06~0.12)	0.1 (0.06~0.12)
	Titanium Alloy (Wet) (Ti-6Al-4V)	-	60 (30~100)	0.05 (0.04~0.08)	0.05 (0.04~0.08)	0.06 (0.04~0.08)	0.06 (0.04~0.08)	0.08 (0.04~0.15)	0.1 (0.06~0.2)	0.14 (0.08~0.2)	0.14 (0.08~0.2)
H	Pre-hardened Steel NAK80	40~43HRC	100 (60~120)	0.06 (0.04~0.1)	0.06 (0.04~0.1)	0.06 (0.04~0.12)	0.07 (0.04~0.12)	0.08 (0.04~0.12)	0.1 (0.06~0.15)	0.1 (0.06~0.15)	0.1 (0.06~0.15)
	Hardened Steel SKD11	50~55HRC	60 (40~80)	0.05 (0.04~0.08)	0.05 (0.04~0.08)	0.05 (0.04~0.08)	0.06 (0.04~0.08)	0.06 (0.04~0.08)	0.08 (0.04~0.1)	0.08 (0.04~0.1)	0.08 (0.04~0.1)

P4D

Work Material	Tensile Strength/Hardness	Vc (m/min)	Feed Rate (mm/rev)								
			ø12~ø14.5	ø15~ø16.5	ø17~ø18.5	ø19~ø20.5	ø21~ø24.5	ø25~ø28.5	ø29~ø33.5	ø34~ø63	
P	Mild Steel-Carbon Steel (S5400-S10C)	~180HB	200 (150~250)	0.06 (0.04~0.08)	0.06 (0.04~0.08)	0.06 (0.04~0.08)	0.07 (0.04~0.1)	0.08 (0.04~0.12)	0.08 (0.04~0.12)	0.1 (0.05~0.15)	0.1 (0.05~0.18)
	Carbon Steel-Alloy Steel (S50C-SCM440)	~280HB	150 (100~220)	0.07 (0.04~0.1)	0.08 (0.04~0.14)	0.08 (0.04~0.16)	0.09 (0.04~0.18)	0.12 (0.04~0.15)	0.18 (0.06~0.25)	0.2 (0.08~0.25)	0.2 (0.08~0.3)
M	Die Steel (SKD11-SKD61)	~280HB	120 (80~180)	0.06 (0.04~0.08)	0.06 (0.04~0.1)	0.07 (0.04~0.1)	0.08 (0.04~0.12)	0.1 (0.04~0.13)	0.14 (0.06~0.2)	0.18 (0.08~0.25)	0.18 (0.08~0.25)
	Stainless Steel (SUS304-SUS420)	~250HB	130 (80~180)	0.06 (0.04~0.08)	0.06 (0.04~0.08)	0.07 (0.04~0.1)	0.08 (0.04~0.1)	0.08 (0.04~0.1)	0.13 (0.06~0.2)	0.15 (0.08~0.2)	0.15 (0.08~0.2)
K	Cast Iron (FC250)	~350N/mm ²	200 (150~280)	0.08 (0.04~0.12)	0.08 (0.04~0.14)	0.09 (0.04~0.16)	0.1 (0.04~0.2)	0.12 (0.04~0.15)	0.2 (0.06~0.3)	0.2 (0.08~0.3)	0.2 (0.08~0.3)
	Ductile Cast Iron (FCD400)	~800N/mm ²	160 (100~220)	0.08 (0.04~0.1)	0.08 (0.04~0.1)	0.08 (0.04~0.12)	0.09 (0.04~0.15)	0.12 (0.04~0.15)	0.15 (0.06~0.25)	0.18 (0.08~0.25)	0.18 (0.08~0.25)
N	Alluminium Alloy	~13%Si	200 (100~800)	0.07 (0.04~0.12)	0.07 (0.04~0.12)	0.09 (0.04~0.12)	0.12 (0.04~0.2)	0.14 (0.04~0.2)	0.2 (0.06~0.3)	0.2 (0.08~0.3)	0.2 (0.08~0.3)
S	Heat Resistant Alloy (Wet) (Inconel 718)	-	30 (15~50)	0.04 (0.02~0.06)	0.04 (0.02~0.06)	0.04 (0.02~0.06)	0.04 (0.02~0.06)	0.05 (0.04~0.08)	0.07 (0.06~0.1)	0.08 (0.06~0.12)	0.08 (0.06~0.12)
	Titanium Alloy (Wet) (Ti-6Al-4V)	-	60 (30~100)	0.05 (0.04~0.08)	0.05 (0.04~0.08)	0.06 (0.04~0.08)	0.06 (0.04~0.08)	0.08 (0.04~0.1)	0.1 (0.06~0.2)	0.14 (0.08~0.2)	0.14 (0.08~0.2)
H	Pre-hardened Steel NAK80	40~43HRC	100 (60~120)	0.06 (0.04~0.1)	0.06 (0.04~0.1)	0.06 (0.04~0.1)	0.06 (0.04~0.1)	0.08 (0.04~0.12)	0.08 (0.06~0.12)	0.1 (0.06~0.13)	0.1 (0.06~0.13)
	Hardened Steel SKD11	50~55HRC	60 (40~80)	0.05 (0.04~0.08)	0.05 (0.04~0.08)	0.05 (0.04~0.08)	0.06 (0.04~0.08)	0.06 (0.04~0.08)	0.08 (0.04~0.1)	0.08 (0.04~0.1)	0.08 (0.04~0.1)

PHP instructions also valid for P2D

P5D

Work Material	Tensile Strength/Hardness	Vc (m/min)	Feed Rate (mm/rev)								
			ø12~ø14.5	ø15~ø16.5	ø17~ø18.5	ø19~ø20.5	ø21~ø24.5	ø25~ø28.5	ø29~ø33.5	ø34~ø63	
P	Mild Steel-Carbon Steel (S5400-S10C)	~180HB	200 (150~250)	0.05 (0.04~0.08)	0.05 (0.04~0.08)	0.06 (0.04~0.08)	0.07 (0.04~0.1)	0.08 (0.04~0.12)	0.08 (0.04~0.12)	0.1 (0.05~0.15)	0.1 (0.05~0.18)
	Carbon Steel-Alloy Steel (S50C-SCM440)	~280HB	150 (100~220)	0.06 (0.04~0.09)	0.06 (0.04~0.09)	0.08 (0.04~0.12)	0.08 (0.04~0.14)	0.12 (0.04~0.15)	0.15 (0.06~0.2)	0.18 (0.08~0.2)	0.18 (0.08~0.25)
M	Die Steel (SKD11-SKD61)	~280HB	120 (80~180)	0.06 (0.04~0.08)	0.06 (0.04~0.08)	0.06 (0.04~0.08)	0.07 (0.04~0.1)	0.1 (0.04~0.13)	0.12 (0.06~0.15)	0.15 (0.08~0.18)	0.16 (0.08~0.22)
	Stainless Steel (SUS304-SUS420)	~250HB	130 (80~180)	0.06 (0.04~0.08)	0.06 (0.04~0.08)	0.06 (0.04~0.08)	0.07 (0.04~0.09)	0.08 (0.04~0.1)	0.1 (0.06~0.15)	0.12 (0.06~0.18)	0.12 (0.06~0.2)
K	Cast Iron (FC250)	~350N/mm ²	200 (150~280)	0.06 (0.04~0.1)	0.06 (0.04~0.1)	0.08 (0.04~0.12)	0.08 (0.04~0.13)	0.12 (0.04~0.15)	0.15 (0.06~0.2)	0.18 (0.08~0.2)	0.18 (0.08~0.25)
	Ductile Cast Iron (FCD400)	~800N/mm ²	160 (100~220)	0.06 (0.04~0.09)	0.06 (0.04~0.09)	0.08 (0.04~0.12)	0.08 (0.04~0.12)	0.1 (0.04~0.13)	0.12 (0.06~0.15)	0.15 (0.08~0.18)	0.18 (0.08~0.25)
N	Alluminium Alloy	~13%Si	200 (100~800)	0.06 (0.04~0.1)	0.06 (0.04~0.1)	0.09 (0.04~0.12)	0.1 (0.04~0.15)	0.12 (0.04~0.15)	0.15 (0.06~0.25)	0.2 (0.08~0.3)	0.2 (0.08~0.3)
S	Heat Resistant Alloy (Wet) (Inconel 718)	-	30 (15~50)	0.04 (0.02~0.06)	0.04 (0.02~0.06)	0.04 (0.02~0.06)	0.04 (0.02~0.06)	0.04 (0.02~0.06)	0.07 (0.06~0.08)	0.07 (0.06~0.08)	0.07 (0.06~0.08)
	Titanium Alloy (Wet) (Ti-6Al-4V)	-	60 (30~100)	0.05 (0.04~0.08)	0.05 (0.04~0.08)	0.06 (0.04~0.08)	0.06 (0.04~0.08)	0.06 (0.04~0.1)	0.08 (0.06~0.15)	0.1 (0.08~0.15)	0.1 (0.08~0.15)
H	Pre-hardened Steel NAK80	40~43HRC	100 (60~120)	0.06 (0.04~0.08)	0.06 (0.04~0.08)	0.06 (0.04~0.08)	0.06 (0.04~0.08)	0.08 (0.04~0.1)	0.08 (0.06~0.12)	0.1 (0.06~0.12)	0.1 (0.06~0.12)
	Hardened Steel SKD11	50~55HRC	60 (40~80)	0.05 (0.04~0.07)	0.05 (0.04~0.07)	0.05 (0.04~0.07)	0.06 (0.04~0.07)	0.06 (0.04~0.08)	0.07 (0.04~0.1)	0.08 (0.04~0.1)	0.08 (0.04~0.1)

Drilling | Indexable

Body

MAXIMUM OFFSET AMOUNT FOR DRILLING WITH ROTATION OF WORK MATERIALS

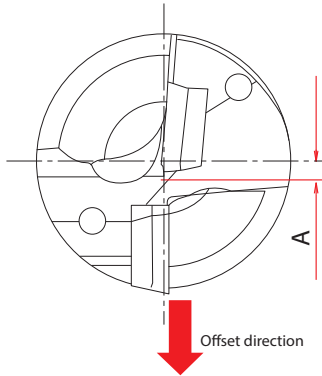
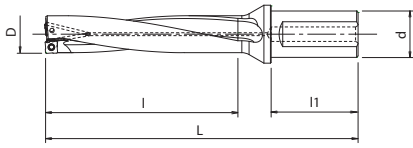

D	D + A offset Amount	D Max.
12	0,4	12,8
12,5	0,4	13,3
12,7	0,3	13,3
13	0,3	13,6
13,5	0,2	13,9
14	0,2	14,4
14,5	0,1	14,7
15	0,4	15,8
15,5	0,3	16,1
16	0,3	16,6
16,5	0,3	17,1
17	0,6	18,2
17,5	0,5	18,5
18	0,5	19
18,5	0,4	19,3
19	0,6	20,2
19,5	0,5	20,5
20	0,4	20,8
20,5	0,4	21,3
21	1	23
21,5	0,9	23,3
22	0,8	23,6
22,5	0,7	23,9
23	0,5	24
23,5	0,4	24,3
24	0,3	24,6
24,5	0,2	24,9
25	1,1	27,2
25,5	0,9	27,3
26	0,8	27,6
26,5	0,7	27,9
27	0,6	28,2
28	0,3	28,6
28,5	0,2	28,9
29	1,3	31,6
30	1,1	32,2
31	0,8	32,6
32	0,6	33,2
33	0,3	33,6
33,5	0,2	33,9
34	1,1	36,2
35	0,8	36,6
36	0,8	37,6
37	0,6	38,2
38	0,3	38,6
39	1,0	41,0
40	0,9	41,8
41	0,8	42,6
42	0,6	43,2
43	0,5	44,0
44	0,3	44,6
45	0,9	46,8
46	0,8	47,6
47	0,7	48,4
48	0,5	49,0
49	0,3	49,6
50	1,1	52,2
51	1,0	53,0
52	0,8	53,6
53	0,7	54,4
54	0,6	55,2
55	0,4	55,8
56	0,1	56,2
57	1,1	59,2
58	1,0	60,0
59	0,9	60,8
60	0,8	61,6
61	0,6	62,2
62	0,4	62,8
63	0,2	63,4

Drilling | Indexable



Maximum offset

TAP PILOT HOLE SIZE CHART

Drilling | Indexable

Thread Size	Recommended tap drill hole diameter	Min. drill hole dia	Max. drill hole dia.	Applicable Body		Recommended Tap Series	
				6H	P2D	P3D	A-SFT
M14X2	12	11,84	12,21	P2D1200FS20M03	P3D1200FS20M03	48139191	48145191
M14X1,5	12,5	12,38	12,67	P2D1250FS20M03	P3D1250FS20M03	-	-
M16X2	14	13,9	14,21	P2D1400FS20M03	P3D1400FS20M03	48139202	48145202
M16X1,5	14,5	14,4	14,67	P2D1450FS20M03	P3D1450FS20M03	-	-
M17x1,5	15,5	15,4	15,67	P2D1550FS20M04	P3D1550FS20M04	-	-
M18x2,5	15,5	15,3	15,74			48139214	48145214
M18x2	16	15,9	16,21	P2D1600FS20M04	P3D1600FS20M04	-	-
M18x1,5	16,5	16,4	16,67	P2D1650FS20M04	P3D1650FS20M04	48139216	48145216
M20x2,5	17,5	17,3	17,74	P2D1750FS20M05	P3D1750FS20M05	48139228	48145228
				P2D1750FS25M05	P3D1750FS25M05		
M20x2	18	17,9	18,21	P2D1800FS25M05	P3D1800FS25M05	48139220	48145220
M20x1,5	18,5	18,4	18,67	P2D1850FS25M05	P3D1850FS25M05	48139230	48145230
M22x2,5	19,5	19,3	19,74	P2D1950FS25M06	P3D1950FS25M06	48139238	48145238
M22x2	20	19,9	20,21	P2D2000FS25M06	P3D2000FS25M06	48139239	48145239
M22x1,5	20,5	20,4	20,67	P2D2050FS20M06	P3D2050FS20M06	48139240	48145240
M24x3	21	20,8	21,25	P2D2100FS25M07	P3D2100FS25M07	48139247	48145247
M24x2	22	21,9	22,21	P2D2200FS25M07	P3D2200FS25M07	48139249	48145249
M24x1,5	22,5	22,4	22,67	P2D2250FS25M07	P3D2250FS25M07	48139250	48145250
M27x3	24	23,8	24,25	P2D2400FS25M07	P3D2400FS25M07	48140262	-
				P2D2400FS32M07	P3D2400FS32M07		
M27x1,5	25,5	25,4	25,67	P2D2550FS25M08	P3D2550FS25M08	-	-
				P2D2550FS32M08	P3D2550FS32M08		
M30x3,5	26,5	26,3	26,77	P2D2650FS32M08	P3D2650FS32M08	48140271	-
M30x3	27	26,8	27,25	P2D2700FS32M08	P3D2700FS32M08	-	-
M30x1,5	28,5	28,4	28,67	P2D2850FS32M08	P3D2850FS32M08	-	-
M36x4	32	31,7	32,27	P2D3200FS32M09	P3D3200FS32M09	48140294	-
				P2D3200FS40M09	P3D3200FS40M09		
M36x3	33	32,8	33,25	P2D3300FS40M09	P3D3300FS40M09	-	-
M39x4	35	34,7	35,27	P2D3500FS40M10	P3D3500FS40M10	48140304	-
M42x3	39	38,8	39,25	P2D3900FS40M12	P3D3900FS40M12	-	-
M48x5	43	42,6	43,29	P2D4300FS40M12	P3D4300FS40M12	48140325	-
M48x3	45	44,8	45,25	P2D4500FS40M13	P3D4500FS40M13	-	-

For additional sizes and styles, please refer to the high efficiency, multi-purpose A-Tap series catalog.

Tap recommendation

Need a thread? Please consider trying our A-Tap (cutting tap) and/or XPF Tap series (forming) after drilling

- A-Tap Series

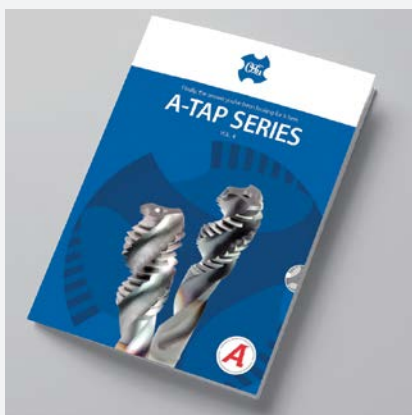

The new industry standard for stable threading.

- XPF Series



Superior forming taps that stably make threads without creating chips.

Drilling | Indexable

Tap pilot hole size chart



shaping your dreams

OSG EUROPE LOGISTICS

Avenue Lavoisier 1
B-1300 Z.I. Wavre - Nord - Belgium
Tel: +32 10 23 05 07
Fax: +32 10 23 05 51
info@osgeurope.com

OSG BELUX

Avenue Lavoisier 1
B-1300 Z.I. Wavre - Nord - Belgium
Tel: +32 10 23 05 11
Fax: +32 10 23 05 31
info@osg-belgium.com

OSG FRANCE

Parc Icade, Paris Nord 2
Immeuble "Le Rimbaud"
22 Avenue des Nations
CS66191 - 93420 Villepinte - France
Tel: +33 1 49 90 10 10
Fax: +33 1 49 90 10 15
sales@osg-france.com

OSG NETHERLANDS

Bedrijfsweg 5 - 3481 MG Harmelen
Tel: +31 348 44 2764
Fax: +31 348 44 2144
info@osg-nl.com

OSG UK

Shelton house, 5 Bentalls
Pipps Hill Ind Est, Basildon Essex SS14 3BY
Tel: +44 845 305 1066
Fax: +44 845 305 1067
sales@osg-uk.com

SLOVAKIA

Branch office of OSG Europe Logistics s.a.
Tel (SK) +421 2 4329 1295
Tel (BE) +32 10 23 05 07
Fax (BE) +32 10 23 05 51
sales-osgsvk@osgeurope.com

OSG POLAND Sp. z.o.o.

Spółdzielcza 57
05-07 Halinów - Poland
Tel: +22 760 82 71
Fax: +22 760 82 71
osg@osg-poland.com

OSG GERMANY

Karl-Ehmann-Str. 25
D - 73037 Göppingen - Germany
Tel: +49 7161 6064 - 0
Fax: +49 7161 6064 - 444
info@osg-germany.de

OSG SCANDINAVIA

(For Scandinavian countries)
Langebjergvaenget 16
4000 Roskilde - Denmark
Tel: +45 46 75 65 55
Fax: +45 46 75 67 00
osg@osg-scandinavia.com

SWEDEN

Branch office of OSG SCANDINAVIA
Abrahams Gränd 8
295 35 Bromölla - Sweden
Tel: +46 40 41 22 55
Fax: +46 40 41 32 55
osg@osg-scandinavia.com

OSG IBERICA

Bekolarra 4
E - 01010 Vitoria-Gasteiz - Spain
Tel: +34 945 242 400
Fax: +34 945 228 883
osg.iberica@osg-ib.com

RUSSIA

Butlerova street, 17B, office 5069
117342 Moscow - Russia
Tel: +7 (495) 150 41 54
info@osg-russia.com

OSG TURKEY

Rami Kişla Cad.No:56 Eyüp
Istanbul 34056 - Turkey
Tel:+90 212 565 24 00
Fax: +90 212 565 44 00
info@osg-turkey.com

ROMSAN INTERNATIONAL CO. SRL

Reprezentant Exclusiv OSG
23-25, Nerva Traian Street
031044 Bucuresti - România
Tel: +40 021 322 07 47
Fax: +40 021 321 56 00
romsan.int@romsan.ro

AUSTRIA

Branch office of OSG GERMANY
Messestraße 11
A-6850 Dornbirn
Tel: +49 7161 6064-0
Fax: +49 7161 6064-444
info@osg-germany.de

OSG ITALIA

Via Cirenaiica n. 52 int. 61/63
I - 10142 Torino - Italy
Tel: +39 011770521
Fax: +39 0117705215
info@osg-italia.it

Vischer & Bolli AG

Machining and Workholding
Im Schossacher 17
CH-8600 Dübendorf
T +41 44 802 15 15
F +41 44 802 15 95
info@vb-tools.com

OSG EUROPE LOGISTICS S.A.

07/2019 - All rights reserved. © OSG Europe 2019.

The contents of this catalogue are provided to you for viewing only. They are not intended for reproduction either in part or in whole in this or other medium. They cannot be copied, used to create derivation work or used for any reason, by means without the express, written permission of the copyright owner. If prices are stated, they are netto unit-prices and any eventual tax(es) have to be added. The company is not responsible for any printing error in technical, price and/or any other data.

Tool specifications subject to change without notice.

www.osgeurope.com